



华显美
HUA XIAN MEI

Product Specification

产品规格书

产品生产商：深圳市华显美科技有限公司

产品名称：1.45寸360*360点阵彩屏模组

规格型号：HXM146001C22-V1

部门确认：

研发	工程	品管	审核

印章：

日期：

客户回签：

采购	工程	品管	确认

印 章:

日 期:

Table of Contents

REVISION HISTORY	3
1. GENERAL DESCRIPTION	4
1.1 DESCRIPTION.....	4
1.2 GENERAL INFORMATION.....	4
2. ABSOLUTE MAXIMUM RATING	5
3. ELECTRICAL CHARACTERISTICS	6
3.1 LCM DC CHARACTERISTICS	6
3.2 BACK-LIGHT UNIT CHARACTERISTICS.....	6
4. OPTICAL CHARACTERISTICS	7
5. MODULE OUTLINE DIMENSION	10
6. MODULE INTERFACE DESCRIPTION	11
7. REFERENCE APPLICATION CIRCUIT	13
8. TIMINGS FOR MCU Interface	13
9. RELIABILITY TEST CONDITIONS	14
10. PACKING	14
11. INSPECTION CRITERION	15
12. GENERAL PRECAUTIONS	19

1. GENERAL DESCRIPTION

1.1 DESCRIPTION

HXM146001C22-V1 is a transmissive type color active matrix TFT (Thin Film Transistor) liquid crystal display (LCD) that uses amorphous silicon TFT as a switching device. This model is composed of a TFT-LCD module (TFT-LCD panel, driver IC and FPC), a back-light unit and. The resolution of 1.47" contains 360 RGB X360 pixels and can display up to 262k colors.

1.2 GENERAL INFORMATION

Items	Specification	Unit	Note
Drive element	a-Si TFT	-	-
LCM outline size	39.24 (H) x 41.01 (V)	mm	
Active area	36.94 (H) x 36.94 (V)	mm	-
Number of pixels	360(H)X360(V)	pixels	-
Pixel arrangement	RGB stripe	-	-
Pixel Pitch	102.6x 102.6	mm	-
Display color	262k	color	-
Viewing direction	ALL	-	-
Controller / Driver	ST77916	-	-
Data interface	MCU8BIT	-	
Backlight	2 White LEDs In Parallels	-	
Weight	TBD	g	

2. ABSOLUTE MAXIMUM RATING

(Ta=25±2°C, Vss=GND=0V)

Characteristics	Symbol	Min.	Typ	Max.	Unit	Notes
Supply Voltage	IOVCC	-0.3	-	4.6	V	
	VCI	-0.3	-	4.6	V	
TFT Gate On voltage	VGH	-0.3	-	30	V	
TFT Gate Off voltage	VGL	-0.3	-	30	V	
Backlight Forward Current	I _F	-		40	mA	
Operating Temperature	T _{OPR}	-20		+70	°C	(1), (3)
Storage Temperature	T _{STG}	-30		+80	°C	(2), (3)
Humidity	RH	-		90	%	Max. 60 °C

Notes:

- (1) In case of below 0°C, the response time of liquid crystal (LC) becomes slower and the color of panel becomes darker than normal one. Level of retardation depends on temperature, because of the LC characteristics.
- (2) If product is exposed to high temperatures for extended time, there is a possibility of the polarizer film damage which could degrade the optical characteristics.
- (3) Permanent damage to the device may occur if maximum values are exceeded or reverse voltage is loaded.
Functional operation should be restricted to the conditions described under normal operating conditions.

3. ELECTRICAL CHARACTERISTICS

3.1 LCM DC CHARACTERISTICS

(Ta=25±2°C)

Characteristics	Symbol	Min.	Typ.	Max.	Unit	Note
Power Supply Voltage 1	IOVCC	1.65	1.8	3.3	V	
Power Supply Voltage 2	VCI	2.65	2.8	3.3	V	
Power Supply Voltage 3	-	-	-	-	V	
Power Supply for MTP	VPP	-	-	-	V	
Current Consumption	I _{DD}	-	TBD	-	mA	Normal mode
	I _{DD-SLEEP}		TBD		uA	Sleep mode
Input voltage "L" Level	V _{IL}	GND	-	0.3IOVCC	V	IOVCC=1.65~3.3
Input voltage "H" Level	V _{IH}	0.7IOVCC	-	IOVCC	V	
Output voltage "L" Level	V _{oL}	0	-	0.2IOVCC	V	I _{oL} =1mA
Output voltage "H" Level	V _{oH}	0.8IOVCC	-	IOVCC	V	I _{oH} =-1mA

3.2 BACK-LIGHT UNIT CHARACTERISTICS

The back-light system is an edge-lighting type with 4 white LEDs. The characteristics of the back-light are shown in the following tables.

(Ta=25±2°C)

Characteristics	Symbol	Condition	Min.	Type	Max.	Unit	Notes
Forward Voltage	V _f	I _L =60mA	3.0	-	3.2	V	-
Forward current	I _L		-	40	-	mA	-
Luminance	L _v	I _L =60mA	TBD	TBD	--	cd/m ²	-
LED life time	-	I _L =60mA	20,000	25,000	--	Hr	Note 1

Note:

- (1) The "LED life time" is defined as the module brightness decrease to 50% of original brightness at I_L=80mA. The LED life time could be decreased if operating I_L is larger than 80mA.

Bcklight circuit diagram shown in below:

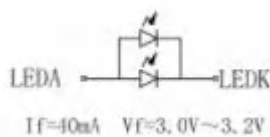

4. OPTICAL CHARACTERISTICS

The following items are measured under stable conditions. The optical characteristics should be measured in a dark room.

Measuring equipment: BM-5AS, BM-7, EZ-Contrast.

(Ta=25±2°C)

Parameter		Symbol	Condition	Min.	Typ.	Max.	Unit	Note
Contrast Ratio (Center point)		C/R	-	900	1200	-	-	BM-7 Note(2)
Luminance of white (Center point)		L _w	B/L on	15%	TBD	15%	cd/m ²	CA-210
Luminance uniformity		U _w	θ = 0. Normal viewing angle B/L On Note(1)	80	-	-	%	BM-7 Note(3)
Response Time		Tr + Tf		-	35	40	ms	BM-5AS Note(4)
Color Chromaticity (CIE 1931)	White	W _x	θ = 0. Normal viewing angle B/L On Note(1)	0.264	0.294	0.324	-	CA-210 Note(5)
		W _y		0.293	0.323	0.353		
	Red	R _x		0.632	0.662	0.692		
		R _y		0.289	0.319	0.349		
	Green	G _x		0.224	0.254	0.284		
		G _y		0.552	0.582	0.612		
	Blue	B _x		0.101	0.137	0.167		
		B _y		0.062	0.092	0.122		
Viewing Angle	Hor.	θ _T	C/R≥10	80	85	-	Deg	EZ Contrast Note(6)
		θ _B		80	85	-		
	Ver.	θ _L		80	85	-		
		θ _R		80	85	-		
Optima View Direction			ALL				Note(7)	

* This condition will be changed by the evaluation circumstance. If product is exposed to high temperatures for extended time, there is a possibility of the polarizer film damage which could degrade the optical characteristics.

Notes:

- (1) Test Equipment Setup: After stabilizing and leaving the panel alone at a given temperature for 30min, the measurement should be executed. Measurement should be executed in a stable, windless, and dark room 30min after lighting the back-light. This should be measured in the center of screen.

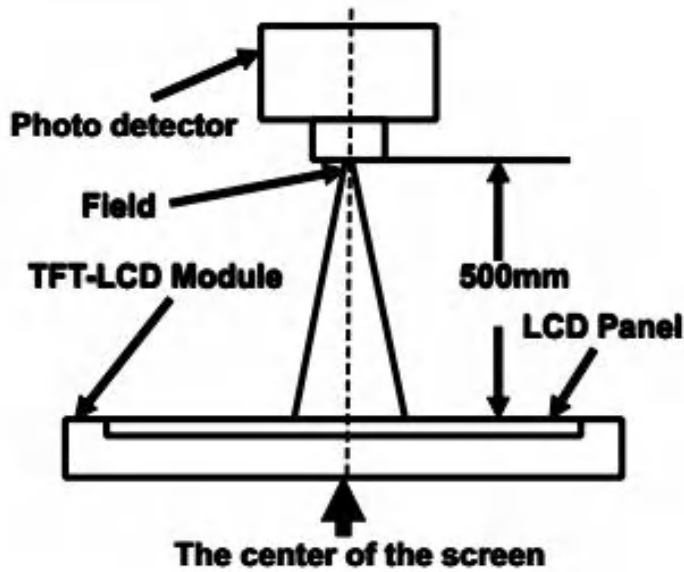

- (2) Definition of Contrast Ratio (CR):

$$\text{Contrast Ratio (CR)} = \frac{\text{Luminance measured when LCD on the "white" state}}{\text{Luminance measured when LCD on the "black" state}}$$

- (3) Definition of Luminance Uniformity: Active area is divided into 9 measuring areas (Shown in below), every measuring point is placed at the center of each measuring area.

$$\text{Luminance Uniformity} = \frac{\text{Min Luminance of white among 9-points}}{\text{Max Luminance of white among 9-points}} \times 100\%$$

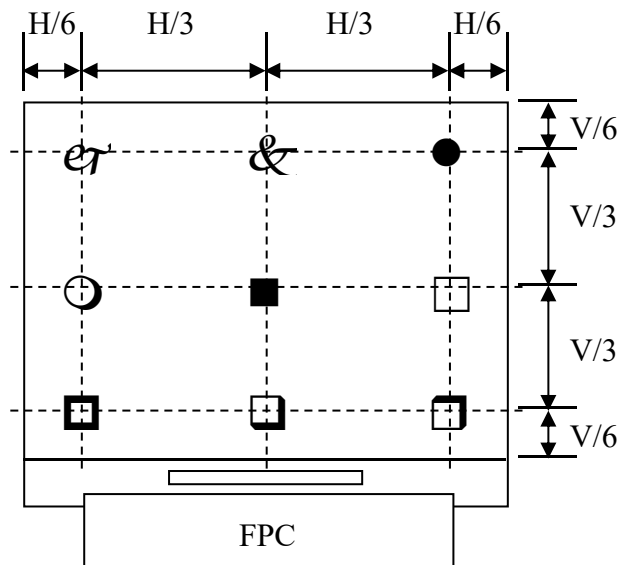

The spot locations for luminance measurement

5. MODULE OUTLINE DIMENSION

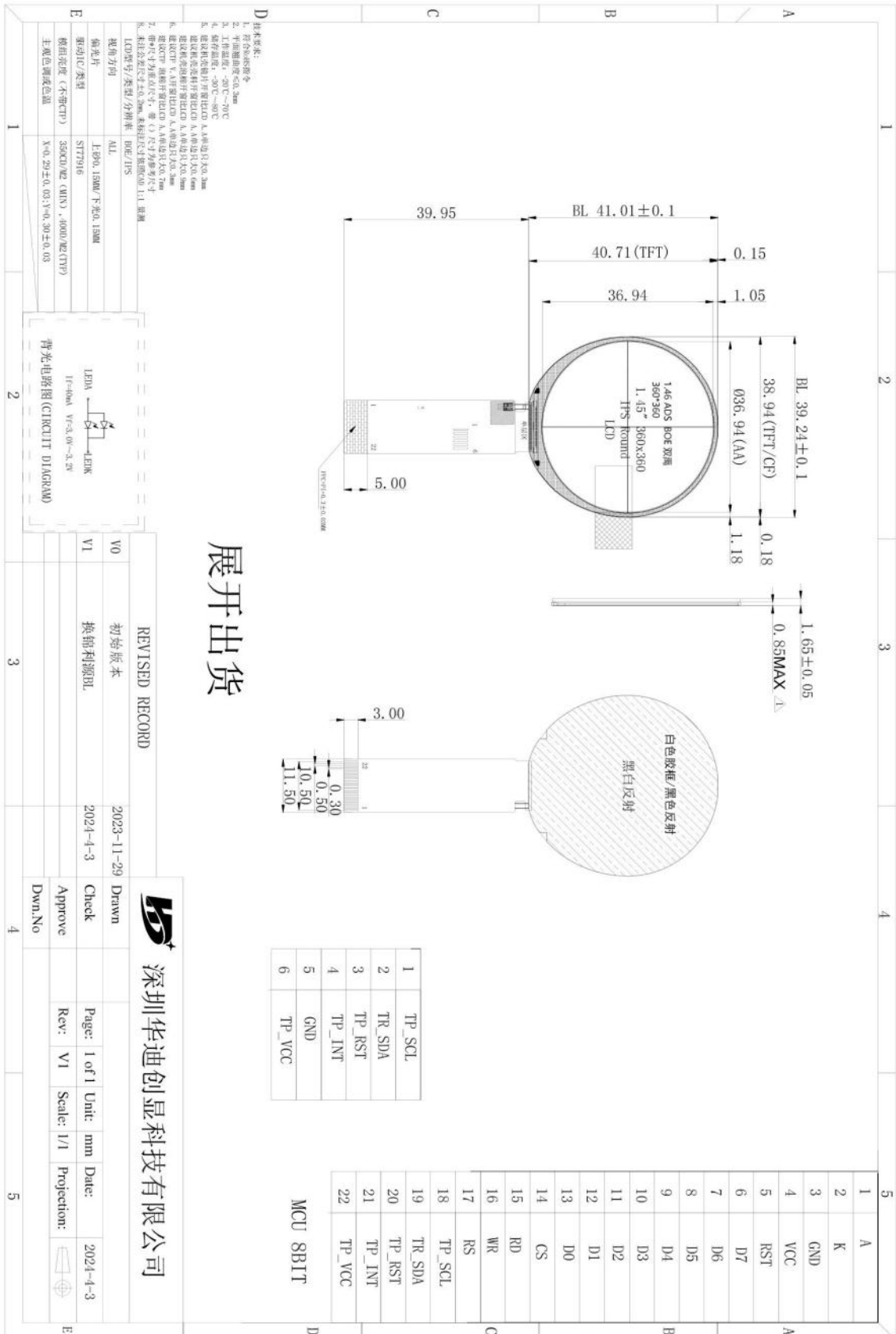

6. MODULE INTERFACE DESCRIPTION

Pin No.	Symbol	Description
1	A	Back-light Anode
2	K	Back-light Cathode
3	GND	Power Ground
4	VCC	Power supply for interface logic circuits(2.8V-3.2V)
5	RST	Reset input pin
6-13	D7-D0	8-bit parallel bi-directional data bus for MCU system Data Bit
14	CS	Chip select input pin
15	RD	Read enable in MCU parallel interface
16	WR	Write enable clock input pin.
17	RS	Register select signal pin. L: Command H: Data
18	TP-SCL	TP-SCL
19	TP-SDA	TP-SDA
20	TP-RST	TP-RST
21	TP-INT	TP-INT
22	TP-VCC	TP-VCC

7. REFERENCE APPLICATION CIRCUIT

Please consult our technical department for detail information.

8.TIMINGS FOR MCU Interface

7.4.1 8080 Series MCU Parallel Interface Characteristics: 8-bit Bus

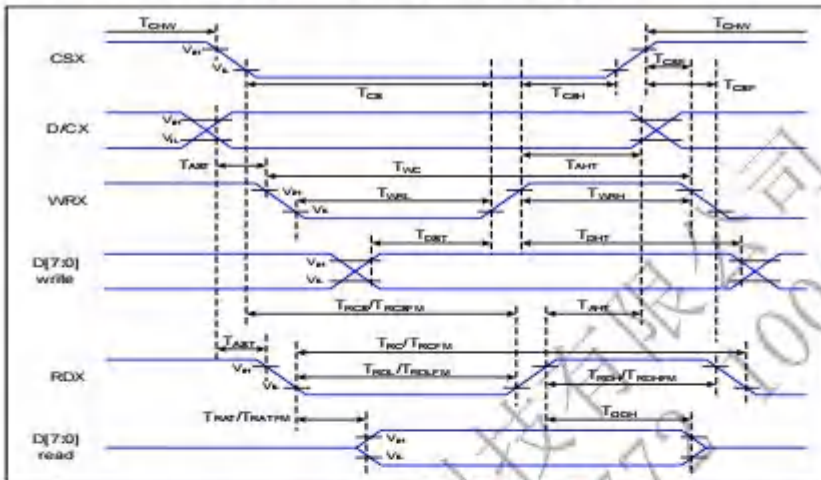

Figure 1 Parallel Interface Timing Characteristics (8080-Series MCU Interface)

$V_{DD1}=1.65$ to $3.3V$, $V_{DD}=2.4$ to $3.3V$, $GND=RGND=0V$, $T_a=25^{\circ}C$

Signal	Symbol	Parameter	Min	Max	Unit	Description
D/CX	T_{AST}	Address setup time	0		ns	
	T_{AHT}	Address hold time (Write/Read)	10		ns	
CSX	T_{CSW}	Chip select "H" pulse width	0		ns	
	T_{CS}	Chip select setup time (Write)	15		ns	
	T_{RCS}	Chip select setup time (Read ID)	45		ns	
	T_{RCFM}	Chip select setup time (Read FM)	355		ns	
	T_{CSH}	Chip select wait time (Write/Read)	10		ns	
	T_{CSH}	Chip select hold time	10		ns	
WRX	T_{WC}	Write cycle	66		ns	
	T_{WRH}	Control pulse "H" duration	15		ns	
	T_{WRL}	Control pulse "L" duration	15		ns	
RDX (ID)	T_{RC}	Read cycle (ID)	160		ns	When read ID data
	T_{RDH}	Control pulse "H" duration (ID)	90		ns	
	T_{RDL}	Control pulse "L" duration (ID)	45		ns	
RDX (FM)	T_{RCFM}	Read cycle (FM)	450		ns	When read from frame memory
	T_{RDHFM}	Control pulse "H" duration (FM)	90		ns	

9.RELIABILITY TEST CONDITIONS

No.	Test Item	Test Condition	Notes
1	High Temperature Storage	+80°C / 240H	Inspection after 2~4h storage at room temperature, the sample shall be free from defects: 1. Air bubble in the LCD; 2. Seal leak; 3. Non-display; 4. Missing segments; 5. Glass crack; 6. The surface shall be free from damage. 7. The electrical characteristics requirements shall be satisfied.
2	Low Temperature Storage	-30°C / 240H	
3	High Temperature Operating	+70°C / 240H	
4	Low Temperature Operating	-20°C / 240H	
5	Temperature Cycle	Ta=-10°C~+25~+50°C, 10 Cycle, per 30min	
6	High Temperature /Humidity storage	60°C ,90%RH / 120H	
7	Vibration Test	Frequency: 10Hz~55Hz~10Hz Amplitude: 1.5mm, 2 hours for each direction of X, Y, Z	
8	Packing Drop Test	Drop to the ground from 1m height, 1 corner, 3 edges, 6 surfaces.	
9	ESD test	Voltage:±8KV R: 330Ω C: 150pF Air discharge, Three or five times.	

Remarks:



- (1) The test samples should be applied to only one test item.
- (2) Sample size for each test item is 5~10pcs.
- (3) For High Temperature/Humidity storage test, pure water (resistance>10MΩ) should be used.
- (4) In case of malfunction defect caused by ESD damage, if it would be recovered to normal state after resetting, it would be judge as a good part.
- (5) Failure judgment criterion: basic specification, electrical characteristic, mechanical characteristic, optical characteristic.

10.PACKING SPECIFICATION

TBD

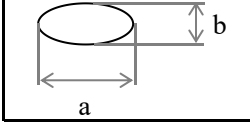
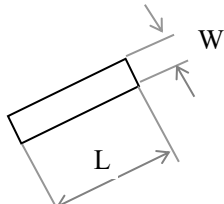
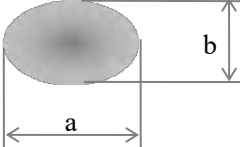
11.INSPECTION CRITERION

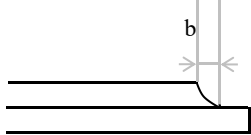
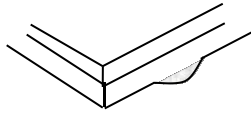
Inspection item		Judgement standard				
		Category		Acceptable number		
				A zone	B zone	
1	Black spot, White spot, Bright Spot, Pinhole Foreign Particle, Bubble and Particle Between polarizer and glass, scratch on polarizer		A B C	$\Phi \leq 0.10$ $0.10 < \Phi \leq 0.20$ $\Phi > 0.2$	Ignored 2 0	Ignored
			Total defective point(B,C)		3	
	Bright spot			$0.15 < \Phi \leq 0.20$	$N \leq 2$	Ignored
	Dark spot/ Black spot			$0.15 < \Phi \leq 0.20$	$N \leq 2$	
	Attached to the two pixels are bright spots			$0.15 < \Phi \leq 0.20$	$N \leq 2$	
	Even a two pixel is dark			$0.15 < \Phi \leq 0.20$	$N \leq 2$	
Pixel total number			$0.15 < \Phi \leq 0.20$	$N \leq 2$		
		Note1: the spot defect caused by foreign matter is judged according to the defect of the foreign body. Note 2: when the light is not wired to show the type of defects.				
2	Black line, White line, Bubble and Particle Between Polarizer and glass, Scratch on polarizer		A B C	$W \leq 0.03 \quad L \leq 3.0$ $0.03 < W \leq 0.05 \quad L \leq 3.0$ $0.05 < W$	Ignored 2 0	Ignored
		W:Width, L:Length(mm)	Total defective point(B,C)		2	
3	Contrast variation		A B C	$\Phi \leq 0.1$ $0.1 < \Phi \leq 0.3$ $\Phi > 0.3$	Ignored 2 0	Ignored
		$\Phi=(a+b)/2(mm)$	Total defective point(B,C)		2	
4	Bubble inside cell			any size	none	none
5	Polarizer defect (if Polarizer is used)	Scratch and damage on polarizer, particle on polarizer or between polarizer and glass.	Refer to item 1 and item 2.			
		Bubble, dent and convex	A B C	$\Phi \leq 0.3$ $0.3 < \Phi \leq 0.5$ $0.5 < \Phi$	Ignored 2 0	Ignored
			Total defective point(B,C)		2	

Inspection item		Judgement standard		
		Category	Acceptable number	
			A zone	B zone
6	Surplus glass	①Stage surplus glass 	$b \leq 0.3\text{mm}$	
		②Surrounding surplus glass 	Should not influence outline dimension and assembling.	
7	MURA	①MURA	Naked eye examination: red, green, blue screen does not allow the appearance, black screen requires visual is not obvious, the specific reference limit samples. Note: the principle of closing the sample is to be installed on the whole machine and the end user will not find it in the normal usage scenario. Inspection basis: 6%ND (MURA mainly in the black screen and indoor light is relatively dark will be found, it is recommended to turn off the indoor lighting inspection.)	
		②Point Black / White / point(MURA) 	1, under the black / gray screen check: $D \leq 0.10\text{mm}$ Ignored; $0.10\text{mm} < D \leq 0.3\text{mm}$, $N \leq 2$; $D > 0.3\text{mm}$: Unqualified. 2, switch to the red, green, blue in which any one of the screen appears black or white or point to point white or point of failure.	

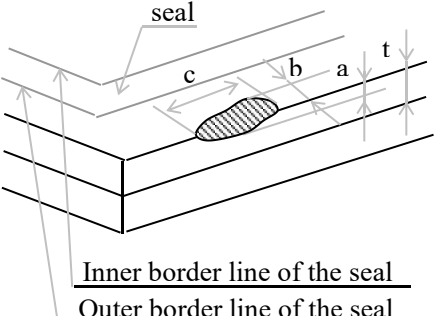
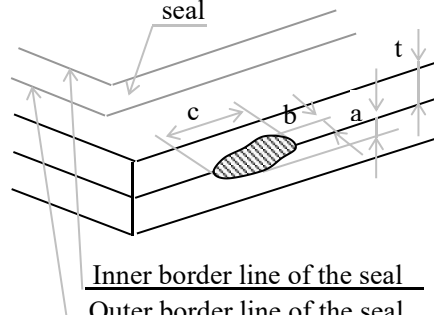
Inspection item		Judgment standard									
		Category(application: B zone)									
8	Glass defect crack	①The front of lead terminals	<table border="1"> <tr> <td>A</td> <td>If $a \leq t$ and $b \leq 1.0$, c is not limited</td> </tr> <tr> <td>B</td> <td>$a \leq t$, $1 \leq b \leq 2\text{mm}$, $c \leq 3\text{mm}$</td> </tr> <tr> <td>C</td> <td>If glass crack cover alignment mark, $b \leq 0.5\text{mm}$.</td> </tr> <tr> <td>D</td> <td>Crack at two sides of lead terminals should not cover patterns and alignment mark</td> </tr> </table>	A	If $a \leq t$ and $b \leq 1.0$, c is not limited	B	$a \leq t$, $1 \leq b \leq 2\text{mm}$, $c \leq 3\text{mm}$	C	If glass crack cover alignment mark, $b \leq 0.5\text{mm}$.	D	Crack at two sides of lead terminals should not cover patterns and alignment mark
		A	If $a \leq t$ and $b \leq 1.0$, c is not limited								
		B	$a \leq t$, $1 \leq b \leq 2\text{mm}$, $c \leq 3\text{mm}$								
		C	If glass crack cover alignment mark, $b \leq 0.5\text{mm}$.								
D	Crack at two sides of lead terminals should not cover patterns and alignment mark										
②Surrounding crack—non-contact side	 <p>$b < \text{Inner borderline of the seal}$</p>										
③ Surrounding crack— contact side	 <p>$b < \text{Outer borderline of the seal}$</p>										
④Corner	<table border="1"> <tr> <td>A</td> <td>$a \leq t$, $b \leq 3.0$, $c \leq 3.0$</td> </tr> </table> <p>*Glass crack should not cover patterns used for</p>	A	$a \leq t$, $b \leq 3.0$, $c \leq 3.0$								
A	$a \leq t$, $b \leq 3.0$, $c \leq 3.0$										

Inspection item		Judgement standard	
9	FPC defect	<p>Component soldering: No cold soldering, short/open circuit, burr, tin ball.</p> <p>The flat encapsulation component position deviation must be less than 1/2 width of the pin (Pic.1);</p> <p>The sheet component deviation: pin deviates from the pad and contact with the near components is not permitted (Pic.2)</p>	<p>Component</p> <p>$L \leq W/2$</p> <p>W</p>
		<p>lead defect:</p> <p>The lead lack must be less than 1/2 of its width;</p> <p>The lead burr must be less than 1/2 of the seam;</p> <p>Impurities connect with the near leads is not permitted</p>	<p>Soldering pad</p> <p>Lead</p> <p>Component</p> <p>$L1 > 0$</p> <p>$L2 > 0$</p>
		<p>Connector soldering:</p> <p>Soldering tin is at contact position of the plug and socket is not permitted</p> <p>No foundation is scald</p> <p>Serious cave distortion on plug and socket contact pin is not permitted</p>	<p>head</p> <p>Base Board</p> <p>Soldering tin is not permit in this area</p> <p>Soldering tin is not permit in this area</p> <p>socket</p> <p>Base Board</p>

12.GENERAL PRECAUTIONS

1.1 HANDING

- (1) When the module is assembled, it should be attached to the system firmly. Be careful not to twist and bent the module.
- (2) Refrain from strong mechanical shock and / or any force to the module. In addition to damage, this may cause improper operation or damage to the module and back-light unit.
- (3) Note that display modules are very fragile and could be easily damaged. Do not press or scratch the surface harder than a HB pencil lead.
- (4) Wipe off water droplets or oil immediately. If you leave the droplets for a long time, straining and discoloration may occur.
- (5) If the display module surface becomes contaminated, breathe on the surface and gently wipe it with a soft dry cloth. If it is heavily contaminated, should be wiped by moisten cloth with isopropyl alcohol or ethyl alcohol solvents, DO NOT with water, ketone type materials (e.g. acetone), aromatic, toluene, ethyl acid or methyl chloride, and so on.
- (6) If the liquid crystal material leaks from the panel, it should be kept away from the eyes or mouth. In case of contact with hands, legs or clothes, it must be washed away thoroughly with soap.
- (7) Use finger-stalls with sort gloves in order to keep display clean during the incoming inspection and assembly process.
- (8) Protection film for polarizer on the module shall be slowly peeled off just before use so that the electrostatic charge can be minimized.
- (9) Do not touch directly conductive parts such as the CMOS LSI pad and the interface terminals with bare hands, therefore operations should be grounded whenever he/she comes into contact with the modules.
- (10) Do not exceed the absolute maximum rating value. (The supply voltage variation, input voltage variation, variation in part contents and environmental temperature, and so on), otherwise the module may be damaged.

1.2 SOLDERING

- (1) Use soldering irons with proper grounding and no leakage.
- (2) For No RoHS Product: soldering temperature is 290~350°C, soldering time is 3~5s; for RoHS Product: soldering temperature is 340~370°C, soldering time is 3~5s.
- (3) If soldering flux is used, be sure to remove any remaining flux after soldering (This does not apply in the case of a non-halogen type of flux).

1.3 STORAGE

- (1) DO NOT leave the module in high temperature and high humidity for a long times, keep the temperature from 0°C to 35°C and relative humidity of less than 60%.
- (2) It is highly recommended to store the module in a dark place. The Liquid crystal is deteriorated by ultraviolet, DO NOT leave it in direct sunlight and strong ultraviolet ray for many hours.